



Product Manual

Brim Chargers

Download Our App



A step by step user guide for your Brim Charger.

CONTENTS

01) Safety and Warning

Safety Instructions	Page 1
Warning Instructions	Page 1

02) Introduction

Product Technical Specifications	Page 2
External Structure	Page 3
Package Contents	Page 3

03) Installation and Preparation

Installation Preparation	Page 4
Installation Process	Page 4
Installation Steps	Page 5

04) Electrical Connection

Charger Appearance	Page 6
Overview of Internal Structure	Page 6
AC Wiring	Page 6

05) Power-On Checks and Charging

Power on Checking	Page 7
Charging Operation	Page 7

06) Troubleshooting

Indicator Status	Page 8
Fault Code and Resolution	Page 9

07) App Setup

App Setup	Page 11
Access Portal (AP) Mode	Page 11

01) Safety Instructions

SAVE THIS BOOKLET. READ ALL INSTRUCTIONS BEFORE INSTALLING OR USING THE CHARGER.

- 1) Keep the charger away from flammable or explosive materials, chemicals, and hazardous substances.
- 2) Keep the charger socket clean and dry. Use a dry cloth for cleaning if necessary.
- 3) Do not touch the socket core while the power is on.
- 4) If the charger is damaged (e.g., cracks or exposed wires), stop using it immediately and contact a qualified technician.
- 5) Do not attempt to disassemble, repair, or modify the charger yourself. Always contact a professional.
- 6) If you notice anything unusual about the device's condition, immediately disconnect the power.
- 7) Protect the charger from rain and lightning during installation.
- 8) Keep children and unauthorized individuals away from the charger.
- 9) Only charge vehicles when stationary, and for hybrid vehicles, ensure the engine is turned off.
- 10) Dispose of packaging responsibly and recycle the charger at an authorised facility according to local regulations.

WARNING

THIS DEVICE OPERATES AT HIGH VOLTAGES, WHICH CAN POSE A SAFETY RISK. ONLY QUALIFIED PERSONNEL SHOULD HANDLE INSTALLATION AND MAINTENANCE.

02) Introduction

2.1 Product Technical Specifications

	Model	BR-AC7000-01
Input	Power Supply	Single - Phase
	Rated Voltage	230V AC
	Rated Current	32A
	Frequency	50/60Hz
Output	Output Voltage	230V AC
	Maximum Current	32A
	Output Power	7.4kW
User Interface	Charging Outlet	Type 2 Cable
	Cable Length	4m
	Housing Material	Plastic PC 940
	LED Indicator	Green / Yellow / Red
	RFID Reader	Mifare ISO / IEC 14443A with 2pcs
	Start Mode	Plug and Play / RFID card / APP
Communication	Communication	WiFi 2.4G
	Protocol	OCPP1.6
Safety	RCD	6mA DC
	Ingress Protection	IP65
	Impact Protection	IK10
	Electrical Protection	Over current Protection, Residual current protection, Ground protection, Surge Protection, Over/Under voltage protection, Over/Under frequency, Over temperature protection, Built-in PEN
	Certification	CE, EN / IEC 61851-1: 2017, EN /IEC 61851-21-2: 2018
	Warranty	3 Years
Environment	Installation	Wall-mount / Floor-mount
	Working Temperature	-30°C ~+ 50°C
	Working Humidity	5% ~ 95%
	Work Altitude	<2000m
Package	Product Dimension	136mm x 204mm x 327mm (H*W*D)
	External Dimension	380mm x 285mm x 175wamm
	Internal Dimension	370mm x 275mm x 160mm
	Gross Weight	



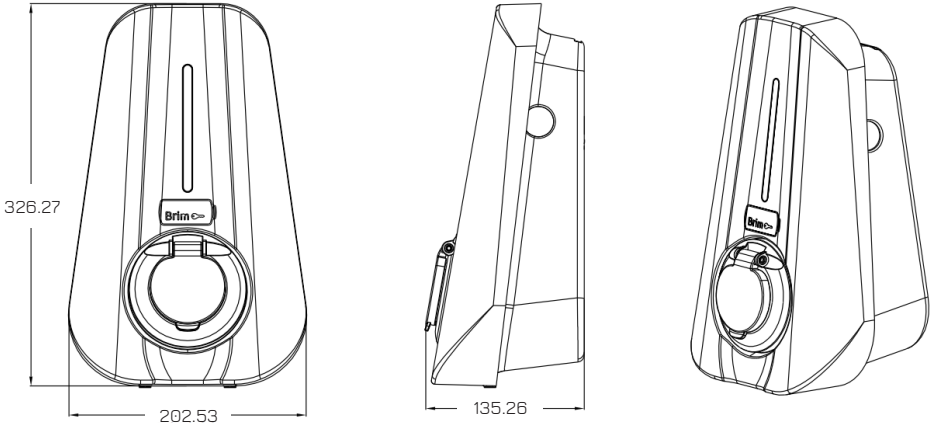





2.2 External Structure

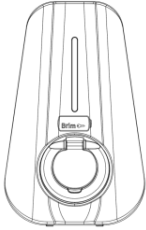
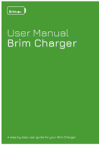

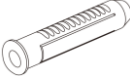
2.3 Package Contents

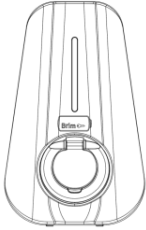

Upon unpacking, check the following:

- 1) Inspect the charger for any visible damage. If found, contact the seller immediately.
- 2) Verify the following contents:

				
	User Manual (x1)	M4*32 Screw (x8)	φ6 Expansion Pipe (x8)	Installation Board (x1)
				
	M4 Hex Key (x1)	Seal Cap (x2)	Insulated Terminal (x3) for Single - Phase	Coupler Holder (x1)

03) Installation and Preparation

3.1 Installation Preparation

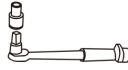
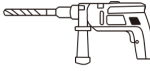
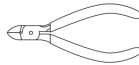
1) Tools Required		
Tool Name	Photo	Function
Multimeter		Check electrical connection and electrical parameter
Cross Screwdriver (PH2 x 150mm, PH3 x 250mm)		Tighten the screws
Insulated Torque Wrench		Tighten the bolts
Electric Drill		Hole on the wall
Diagonal Pliers		Cut cables

2) Cables and Materials		
Name	Specification	Quantity
Power Supply Cable	Single - phase power supply cable	Dependant on specification

3.2 Installation Process

Guidelines:

- Installation, operation, and maintenance must only be carried out by qualified personnel.
- Follow all applicable electrical and safety regulations.
- The integrated RCD is 6mA DC; you must install a Type A breaker.

Pre-installation checks:

- Confirm that the charger location allows for safe and easy access for both use and maintenance.
- Ensure the premises' AC input is properly protected before starting installation.

3.3 Installation Steps

1. Using the installation board as a guide, drill 4 x $\Phi 6\text{mm}$ x 35mm holes in the wall and

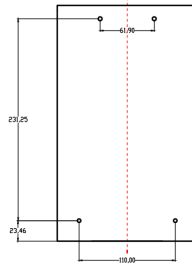

insert the expansion pipes.

2. Partially insert the top 2 M4*32mm screws (these are used for hanging)
3. Remove the charger's upper cover, hang it on the 2 screws, and secure it with 2 additional M4*32mm screws at the bottom. Apply the sealing caps.
4. Connect the cables as described in Section 4.3 (AC Wiring), then close the upper cover and secure it with 2 M4*12mm screws.

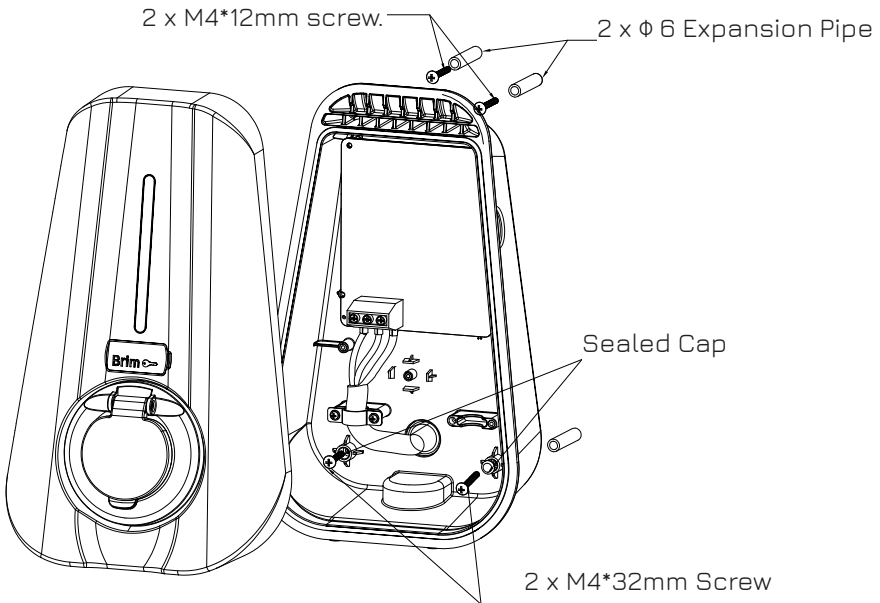

04) Electrical Connection

4.1 Charger Appearance

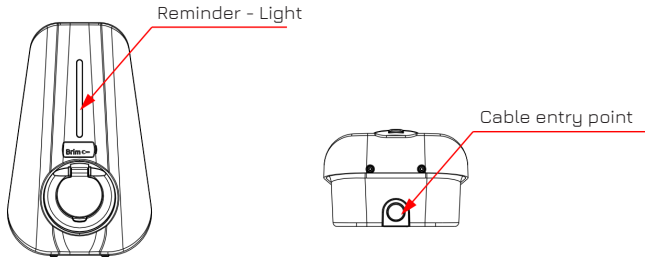

4.2 Overview of Internal Structure

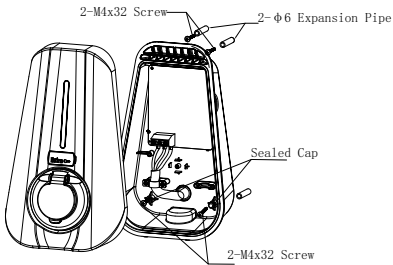

4.3 AC Wiring

NOTE: Ensure the silicone seal is properly cut to maintain the IP65 rating.



1. Strip 40mm of the outer jacket and 8-15mm of the wire insulation.
2. Crimp the terminals and insert the wires into the appropriate slots for either single-phase or three-phase wiring.

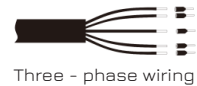
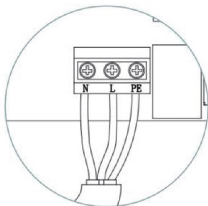

05) Power-On Checks and Charging

Pre-Power-On

1. Ensure the charger is correctly installed and accessible for regular use and maintenance.
2. Verify that all AC input protections are in place.
3. Double-check that the installation is complete and all components are securely fitted.
4. Remove any objects from the top of the charger.

Power-on:

State	Description	LED Status
Standby	Power-on, but no gun plug-in	Flashing green, 1 seconds on; 3 second off
Ready to Charge	Gun plugged in, but charging has not begun	Constantly green
Charging in Progress	Gun plugged in, charging in progress	Breathing green, 1 second on; 1 second off
Fault has occurred	An error condition has occurred; See Section 6 (Troubleshooting) For troubleshooting details	Flashing red or constantly red

1. Connect the charger to the vehicle.
2. The LED indicator will flash yellow, signalling the charger is ready.
3. Download the '**Brim EV**' app from the Play Store or App Store and follow the on-screen instructions to initiate charging.
 - If the app fails to work, use the RFID card provided to start charging, or contact customer support for assistance.
4. Ensure the charging connector is securely plugged into the vehicle. It may take up to 3 minutes for the charger to recognise the connection during the first charge.
5. Check both in the app and in the car to confirm that charging has initiated.

Charging:

- Once connected and recognised, the charging process will begin automatically.
- Charging will stop automatically once the vehicle is fully charged.

06) Troubleshooting

6.1 Indicator Status

LED Colour	State	LED Status
Green	Standby	Flashing green, 1S on, 3S off, Cycle
Green	Suspended EV (Waiting)	Flashing green, 200ms on, 1000ms off, x2, 3S off, Cycle
Green	Plug in Connector	Flashing green, 200ms on, 1000ms off, x5, 3S off, Cycle
Green	Charging	Flashing green, 1S on, 1S off, Cycle
Green	Finished	Solid green light
Yellow	Diconnect Network / Diconnect Server	Solid green light blocks for 1S and flashing yellow, 1S on 3S off
Yellow	Poor Power and Charger in Suspended EV	Solid yellow light blocks 200ms on 500ms off, x5, 3S off
Yellow	Successful Card Swipe	Flashing yellow, 100ms, 100ms off, x5
Yellow	Alarm (relay overtemp load drop, grounding alarm. input terminal overtemp load drop disassembly alarm)	Solid yellow light
Yellow	Charger was Occupied	Flashing yellow, 2S on, 2S off, Cycle
Red	Relay Adhesion	Solid red light
Red	Leakage Current Fault	Flashing red, 500ms on, 500ms off, x1, 3S off, Cycle
Red	CP Fault	Flashing red, 500ms on, 500ms off, x2, 3S off, Cycle
Red	Overcurrent Fault	Flashing red, 500ms on, 500ms off, x3, 3S off, Cycle
Red	Input Polarity Reverse	Flashing red, 500ms on, 500ms off, x4, 3S off, Cycle
Red	Leakage Current Loop Abnormal	Flashing red, 500ms on, 500ms off, x5, 3S off, Cycle
Red	Input Terminal Overtemp	Flashing red, 500ms on, 500ms off, x6, 3S off, Cycle
Red	Relay Overtemp	Flashing red, 500ms on, 500ms off, x7, 3S off, Cycle
Red	Over / Under Voltage Fault	Solid yellow light for 2S and flashing red, 500ms on 500ms off, x1, 3S off, Cycle

Red	Over / Under Frequency Fault	Solid yellow light for 2S and flashing red, 500ms on 500ms off, x2, 3S off, Cycle
Red	Meter Comm Abnormal	Solid yellow light for 2S and flashing red, 500ms on 500ms off, x3, 3S off, Cycle
Red	Smart Meter Comm Abnormal	Solid yellow light for 2S and flashing red, 500ms on 500ms off, x4, 3S off, Cycle
Red	CT Fault	Solid yellow light for 2S and flashing red, 500ms on 500ms off, x5, 3S off, Cycle
Red	Charging Connector Lock Abnormal	Solid yellow light for 2S and flashing red, 500ms on 500ms off, x6, 3S off, Cycle
Red	Charging Connector Current Abnormal	Solid yellow light for 2S and flashing red, 500ms on 500ms off, x7, 3S off, Cycle
White	Security Boot Failed	Flashing white, 200ms on, 1000ms off, x2, 3000ms off, Cycle
White	Upgrade Firmware	Flashing white, 200ms on, 1000ms off, x5, 3000ms off, Cycle
White	POST (Power on Self Test)	Flashing white, 1S on, 1S off, Cycle

6.2 Fault Code and Resolution

Error Code	Problems	Possible Causes	Possible Causes
Over Voltage	Input Over Voltage	AC input voltage may be too high	1) Check the input voltage from the backend
			2) If the voltage is over 267Vac for a short time, wait till the power grid recovers to normal voltage.
Under Voltage	Input Lower Voltage	AC output current may be too large	1) Check the voltage from the backend
			2) If the voltage is under 184Vac for a short time, wait till the power grid recovers to normal voltage range.
Over Current	Output Overload	AC input frequency may be too high	1) Shut off the leakage current protection switch by the power distribution cabinet immediately.
			2) Check whether there is a low resistance connection between the AC output cables on the charger.

Over Frequency	Input Over Frequency	AC input frequency may be too low	1) Check the input voltage frequency from the backend.
			2) If the frequency exceeds 63Hz for a short time, wait till the power grid recovers to a normal voltage range.
Under Frequency	Input Lower Frequency	Temperature may be too low inside the charger	1) Check the input voltage frequency from the backend.
			2) If the frequency is lower than 47Hz for a short time, wait until the the power grid recovers to a normal voltage range.
Over Temperature	Over Temperature	Leakage current to the earth may be too high	1) Check the surrounding condition of the installed charger, and whether there is a heating device nearby. Make sure the environment is under 60°
Over DC Leak	Over Leakage Current	Reverse connection of L/N input cable	1) Shut off the leakage current protection switch on the power distribution grid immediately.
			2) Check whether there is a broken AC output cable or a low resistance connection to the earth.
Phase Error	Reverse Connection	Poor connection of charging cable with EV/Charger	1) Shut off the leakage current protection switch on the power distribution grid immediately.
			2) Check if the AC input / output cables are normal, and if inverse connection of L / N input cables.
Cable RC Error	Charging Cable Connection Abnormal	Poor connection to EV charging cable	1) Check if charging cable connection is correct and firm

NOTE: If the above problems cannot be solved, please contact the seller.

07) App Setup

Download the 'Brim EV' app from the Appstore or Google Playstore, which you can access by scanning one of the QR codes below. Set up your account to start charging.



7.1 Access Portal (AP) Mode

If you were unable to setup and configure your charger on your Wi-Fi network, follow the instructions below to get into AP Mode and connect your charger to your Wi-Fi network

Step 1: Wi-Fi Connection

1. Make sure the Wi-Fi of your phone is enabled.
2. Use the phone to connect to the HotSpot of the charger. The name of the HotSpot begins with **SN1005**.... which is the serial number of the charger. You can find the serial number in the package contents, or on the side of your charger.
3. Enter the default Wi-Fi password which can be found on the user manual, to connect

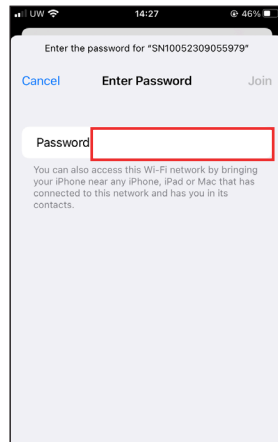
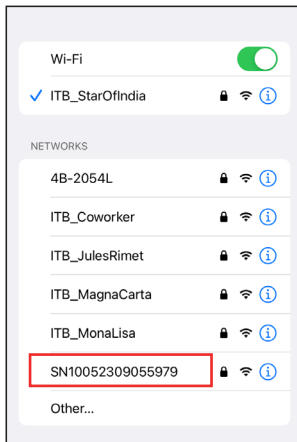

Step 2: Login AP Page

1. Open a browser on your Phone, such as Chrome or Safari, etc.
2. In the address bar, input the address **192.168.4.1**
3. Input the pin code of the charger to login the AP page, this can be found together with your WiFi Password

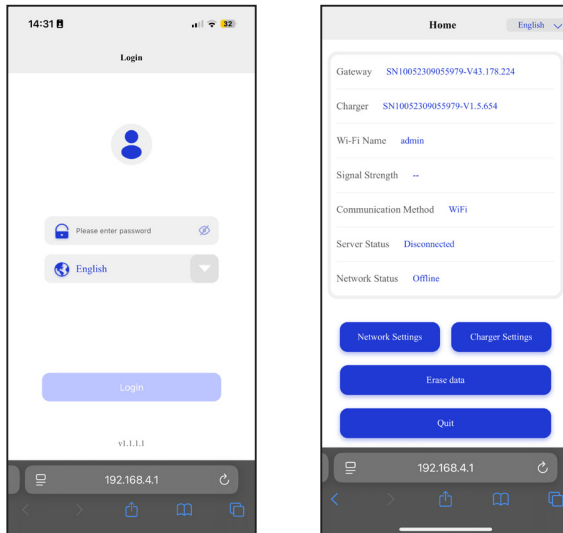

Step 3: Setup

1. After logging into the AP Mode page, click on Network Settings where you can set up the network and URL of the platform.
2. Input Wi-Fi password to let the charger connect to network.
Change the URL from **wss://backend.prod.mybrim.io:80** to **ws://backend.prod.mybrim.io:80**

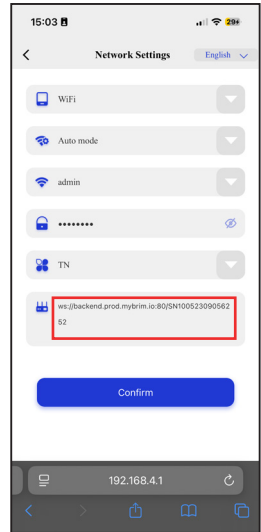
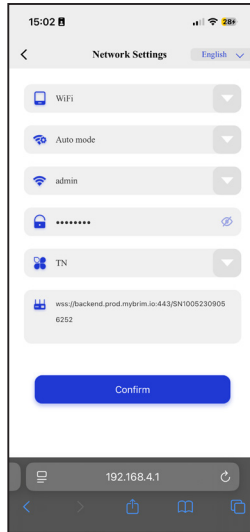
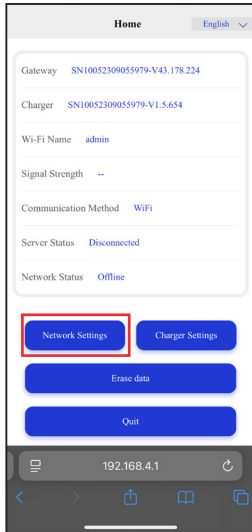

3. After changing the URL, you will be forced to log out. Please re-login and check the server status and network status. If they show **Connected** and **Online**, leave it for a minimum of 10 minutes, and the certificate will be updated automatically. After that, please click on Network settings and change the URL back to: **wss://backend.prod.mybrim.io:80**

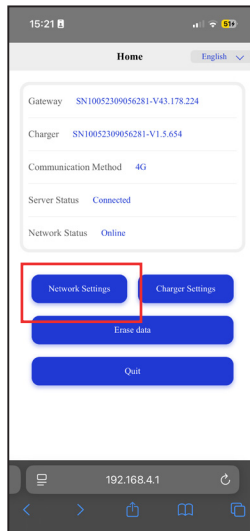



plugmein@fulltothebrim.com

+44 020 7097 5911

www.fulltothebrim.com